

9. Optional Pluggable Module

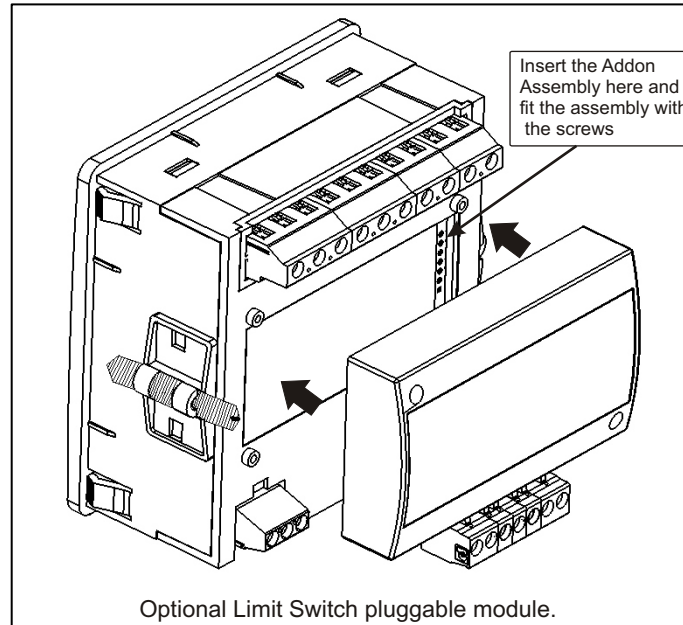

10. Specification :

System

3 Phase 3 Wire / 4 Wire or Single Phase programmable at site

Inputs

Nominal Input Voltage (Three wire and Four wire)	500 V _{L-L} (290V _{L-N})
System Primary Values	100V _{L-L} to 692 kV _{L-L} , programmable at site
System Secondary Values	100V _{L-L} to 500 V _{L-L} , programmable at site
Max continuous input voltage	120% of Rated Value
Max short duration input voltage	2 x Rated Value (1s application repeated 10 times at 10s intervals)
Nominal input voltage burden	0.3VA approx. per phase
Nominal Input Current	1A / 5A AC
Max continuous input current	120% of Rated Value
Nominal input current burden	<0.2VA approx. per phase
Max short duration current input	20 x Rated Value (1s application repeated 5 times at 5 min. intervals)
System CT primary values	Std. Values 1 to 9999A (1 or 5 Amp secondary)
System Secondary Values	1A / 5A, programmable at site

Operating Measuring Ranges

Voltage with external Aux.	10 ... 120 % of Rated Value
Voltage with Self Aux.	25 ... 120% of Rated Value
Current	10 ... 120 % of Rated Value
Frequency	45 .. 65 Hz

Auxiliary

External Auxiliary Supply	40V to 300V AC/DC (+/- 5%)
Self Powered	Input Voltage Range 70 V to 250V L-N (Self Powered meter is available only in 3 Phase 4W and Single phase network)
Frequency Range	45 to 65 Hz
VA Burden	3 VA Approx.

Accuracy

Voltage	±1.0 % of range (20 ... 100% of Rated Value)
Current	±1.0 % of range (10 ... 100% of Rated Value)
Frequency	0.15% of mid frequency

Reference conditions for Accuracy :

Reference temperature	23°C ± 2°C
Input frequency	50 or 60Hz ± 2%
Input waveform	Sinusoidal (distortion factor 0.005)
Auxiliary supply voltage	Rated Value ± 1 %
Auxiliary supply frequency	Rated Value ± 1 %

Relay

Settable parameters	as per table 2
Trip Point setting	10%...120% of set Range of parameter (except frequency which is 10%...100%)
Hysteresis	5% of trip point
Contact type	single pole NO + NC, volt free contacts
Contact rating	250V, 5A

Nominal range of use of influence quantities for measurands

Voltage	10 .. 120 % of Rated Value
Current	Rated Value ± 10 %
Input frequency	10 .. 120 % of Rated Value
Temperature	0 to 50°C
Auxiliary supply voltage	Rated Value ± 5 %
Auxiliary supply frequency	Rated Value ± 10 %
Temperature Coefficient (For Rated value range of use 0... 50°C)	0.05% /°C for Current (10..120% of Rated Value) 0.025% /°C for Voltage (10..120% of Rated Value)
Error change due to variation of an influence quantity	2 * Error allowed for the reference condition applied in the test.

Display

LED	3 line 4 digits, Display height : 14mm
Annunciation of units	Bright LED s from Back side of screen
Update rate	Approx. 1 seconds

Controls

User Interface 4 Keys

Standards

EMC Immunity	IEC 61326 10V/m min-Level 3 industrial low level electromagnetic radiation environment IEC 61000-4-3.
--------------	---

Safety

IEC 61010	
IP for water & dust	IEC 60529

Isolation

Dielectric voltage withstands test between circuits and accessible surfaces	3.3 kV RMS 50 Hz for 1 minute Among all electrical circuits
---	--

Environmental conditions

Operating temperature	0 to 50 °C
Storage temperature	-25 to +70°C
Relative humidity	0 .. 90 % RH (Non condensing)
Warm up time	3 minute (minimum)
Shock	15g in 3 planes
Vibration	10 .. 55 Hz, 0.15mm amplitude
Enclosure front	IP 50
Enclosure back	IP 20

Enclosure

Style	96mm x 96mm DIN Quadratic
Material	Polycarbonate Housing,
Terminals	Screw-type terminals
Depth	< 60 mm
Weight	300 grams Approx.

The information contained in these installation instructions is for use only by installers trained to make electrical power installations and is intended to describe the correct method of installation for this product. However, Company has no control over the field conditions which influence product installation. It is the user's responsibility to determine the suitability of the installation method in the user's field conditions. Company only obligations are those in Company standard Conditions of Sale for this product and in no case will Company be liable for any other incidental, indirect or consequential damages arising from the use or misuse of the products.

Delta 3 LINE

Delta 3Line - 14mm DISPLAY

Programmable Multi-function Digital Panel Meter

Installation & Operating Instructions

Section	Contents
1.	Introduction
2.	Measurement Reading Screens
3.	Programming
3.1	Password Protection
3.2	Set Up Screens
3.2.1	System Type
3.2.2	Potential Transformer Primary value
3.2.3	Current Transformer Primary value
3.2.4	Potential Transformer Secondary value
3.2.5	Current Transformer Secondary value
3.2.6	Reset
3.2.7	Auto Scrolling
3.2.8	Number of poles
3.2.9	Relay Limit Parameter
4.	Run hour
5.	ON hours
6.	Number of interruptions
7.	Installation
7.1	EMC Installation Requirements
7.2	Case Dimensions and Panel Cut-out
7.3	Wiring
7.4	Auxiliary Supply
7.5	Fusing
7.6	Earth / Ground Connections
8.	Connection Diagrams
9.	Optional Pluggable Module
10.	Specification

15000828_Rev. B 26/08/2011

1. Introduction

The Delta 3 Line is a panel mounted 96 x 96mm DIN Quadratic Digital Panel Meter for the measurement of important electrical parameters like AC Voltage, AC Current, RPM, Frequency.

The instrument integrates accurate measurement technology (All Voltages & current measurements are True RMS upto 15th Harmonic) with 3 line 4 digits Ultra high bright LED display with Clearly visible Annunciated units with bright LED from Back side.

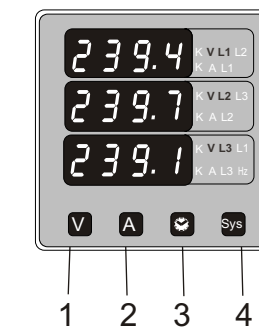

Delta can be configured and Programmed On site for the following : PT Primary, PT Secondary, CT Primary, CT Secondary (5A or 1A) and System Type 3 phase 3W or 4W or single phase system.

The front panel has four push buttons for user interface to scroll through the available parameters. These four keys has function as follow :

- V : Selects & Scrolls through Voltage parameter Display
- A : Select phase Current Parameters Display.
- ☺ : Select & Scrolls through Time parameters : On hr, Run Hr & number of Aux. Supply interruptions. Rotation per minute (RPM)
- Sys : Select & Scroll through System parameters : Voltage, Current, Frequency, max and min Values.

The Delta 3 line come with 14mm display and units annunciated from back side, which enables to take reading from long distance. The problem with conventional LED Annunciators is overcome with Delta 3Line.

TABLE 1:

Measured Parameters	Units of measurement
System Voltage	Volts
System Current	Amps
Frequency	Hz
Voltage VL1-N(4wire only)	Volts
Voltage VL2-N(4wire only)	Volts
Voltage VL3-N(4wire only)	Volts
Voltage VL1-L2	Volts
Voltage VL2-L3	Volts
Voltage VL3-L1	Volts
Current L1	Amps
Current L2	Amps
Current L3	Amps
RPM measurement	RPM
Max. Value System Voltage	V
Max. Value System Current	A
Min. Value System Voltage	V
Min. Value System Current	A
Run Hours	Hrs
ON Hours	Hrs
No. of Auxiliary Interrupts	---- (Counts)

2. Measurement Reading Screens

In normal operation the user is presented with the measurement reading screens. These screens may be scrolled through one at a time by pressing the "A" key for Currents, "V" key for Voltages, "☺" key for RPM, Run Hour, ON hour, No. of Aux. interruptions and "Sys" key for System Voltage, System Current, Frequency, Max Values and min. Values of system Voltage and Current.

Screen 1 : Voltage Line to Neutral
(For 3P4 Wire only)



Screen 2 : Voltage Line to Line
(For 3P4Wire & 3P3 Wire only)



Screen 3 : Voltage Single Phase
(For Single only)

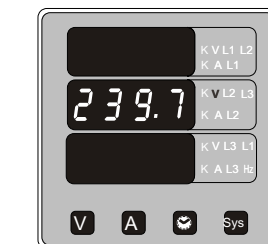

Screen 4 : Line Currents
(For 3P3W and 3P4Wire only)



Screen 5 : Phase Current
(For Single Phase only)

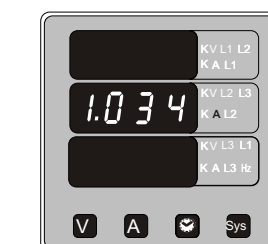

Screen 6 : RPM Measurement

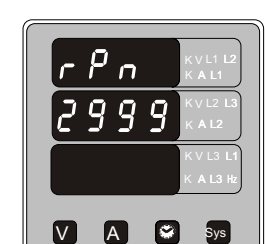

Screen 7 : Run Hours

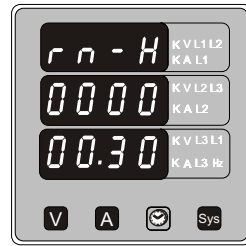

Screen 8 : ON Hours

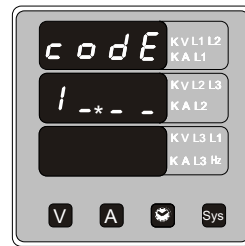
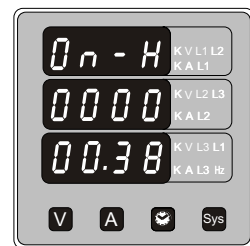

Enter Password, first digit entered, prompt for second digit.
(* Denotes that decimal point will be flashing).

Use the "V" key to scroll the value of the second digit from 0 through to 9, the value will wrap from 9 round to 0.

Press the "A" key to advance to next digit.

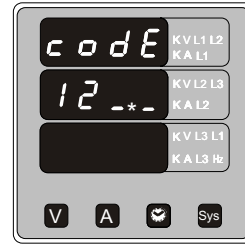

Enter Password, second digit entered, prompt for Third digit.
(* Denotes that decimal point will be flashing).

Use the "V" key to scroll the value of the second digit from 0 through to 9, the value will wrap from 9 round to 0.

Press the "A" key to advance to next digit.

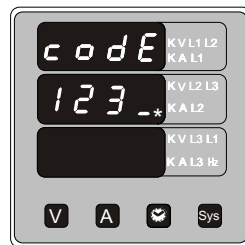

Enter Password, third digit entered, prompt for Fourth digit.
(* Denotes that decimal point will be flashing).

Use the "V" key to scroll the value of the second digit from 0 through to 9, the value will wrap from 9 round to 0.

Press the "A" key to advance to next digit.

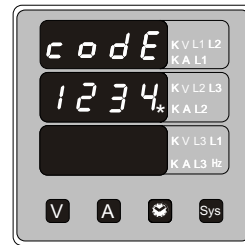

Enter Password, fourth digit entered, awaiting verification of the password.

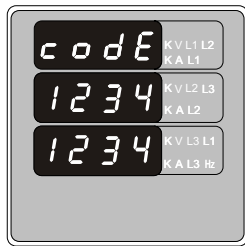

Password confirmed.

Pressing "V" key will advance to the "New / change Password" entry stage.

Pressing the "A" key will advance to the menu Selection screen. (See section 3.2).

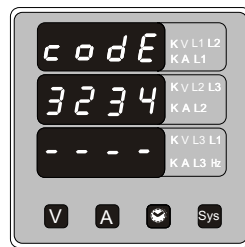

Password incorrect.

The unit has not accepted the Password entered.

Pressing the "V" key will return to the Enter Password stage.

Pressing the "A" Up" key exits the Password menu and returns operation to the measurement reading mode.

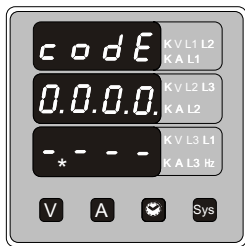

New / Change Password
(*Decimal point indicates that this will be flashing).

Pressing the "V" key will scroll the value of the first Digit from 0 through to 9, the value will wrap from 9 round to 0.

7.2 Case Dimension and Panel Cut Out

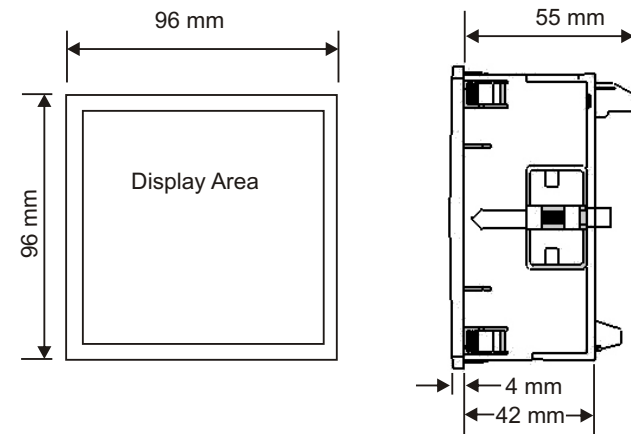

With optional Limit switch.

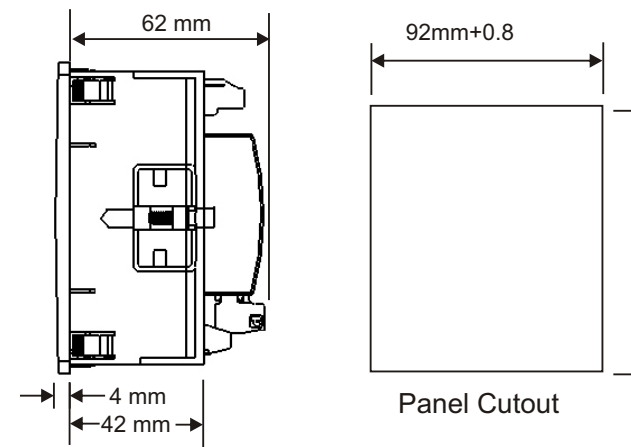

Screen 9 : No. of Interruptions

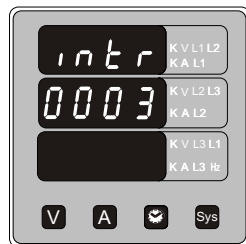

Screen 10 : System Values

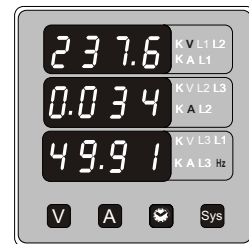

Screen 11 : Max. Values

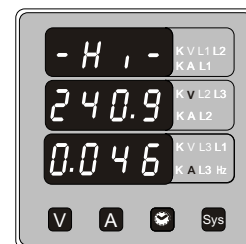

Screen 12 : Min. Values

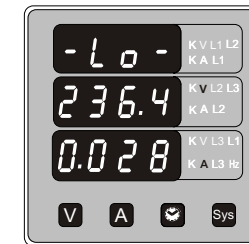

3. Programming

The following sections comprise step by step procedures for configuring the Delta 3 Line for individual user requirements.

To access the set-up screens press and hold the "V" and "A" Keys Simultaneously. This will take the User into the Password Entry Screen (Section 3.1)

3.1. Password Protection

Password protection can be enabled to prevent unauthorized access to set-up screens, by default password protection is not enabled.

Password protection is enabled by selecting a four digit number other than 0000, setting a password of 0000 disables the password protection.

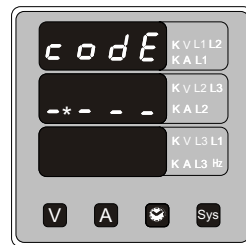

Enter Password, prompt for first digit.
(* Denotes that decimal point will be flashing).

Press the "V" key to scroll the value of the first digit from 0 through to 9, the value will wrap from 9 round to 0.

Press the "A" key to advance to next digit.

In the special case where the Password is "0000" pressing the "A" key when prompted for the first digit will advance to the "Password Confirmed" screen.

8. Connection Diagrams

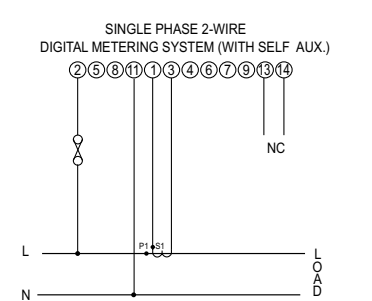
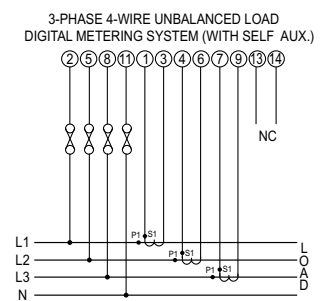
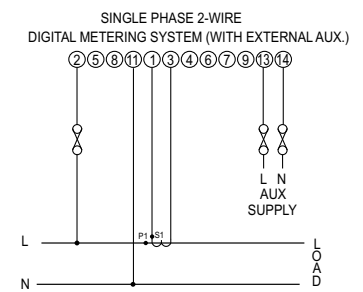
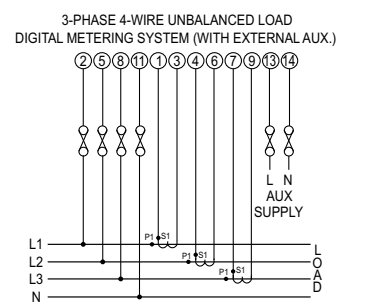
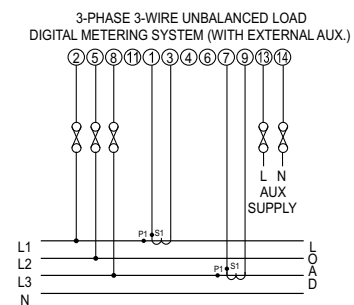
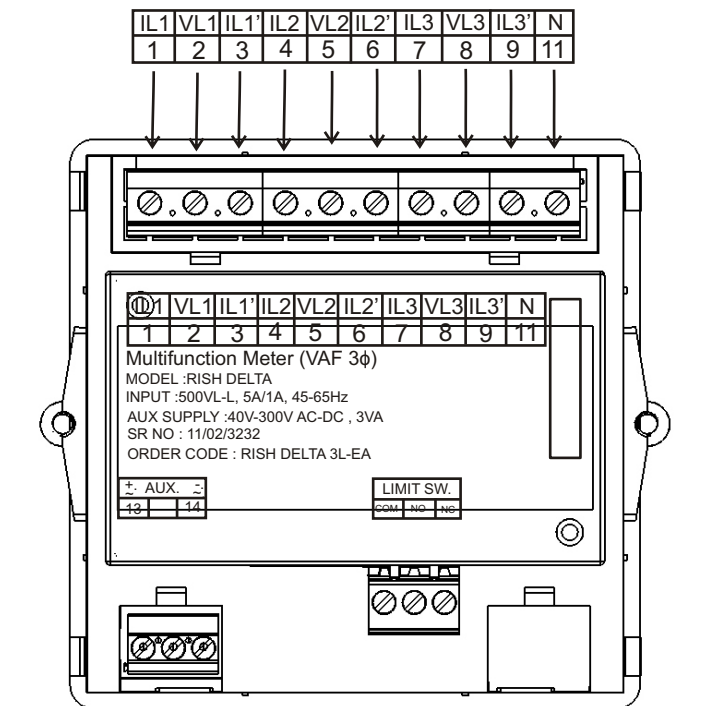

7.3 Wiring

Input connections are made directly to screw-type terminals with indirect wire pressure. Numbering is clearly marked on the connector. Choice of cable should meet local regulations. Terminal for both Current and Voltage inputs will accept upto 4mm² (12AWG) solid or 2.5 mm² (12AWG) standard cable

Note : It is recommended to use wire with lug for connection with meter.

7.4 Auxiliary Supply

Delta 3 Line should ideally be powered from a dedicated supply, however it may be powered from the signal source, provided the source remains within the limits of the chosen auxiliary voltage range.

7.5 Fusing

It is recommended that all voltage lines are fitted with 1 amp HRC fuse.

7.6 Earth/Ground Connections

For safety reasons, CT secondary connections should be grounded in accordance with local regulations.

*Note: For Measurement of parameters, Voltage must be present between terminal 2 & 11 (i.e. phase L1) for single phase or 3 phase 4 wire network and between terminal 2 & 5 (i.e. phase L1-L2) or 2 & 8 (i.e. phase L3-L1) for 3 phase 3 wire network.

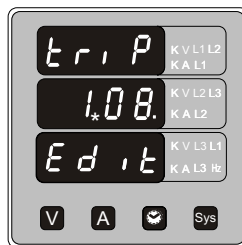

Trip point edit

* denotes that the decimal point will be flashing.

The 100s digit will scroll between 0 and 1, 10s digit will scroll from 1 to 9 if 100s digit is set to 0. If 100s digit is set to 1, the 10s digit will scroll from 0 to 2.

Thus, the trip point can be set as % of the Nominal value of selected parameter (Refer Table 2).

Select the desired trip point as displayed percentage of Set range of the parameter. After Setting LSD, pressing "A" key enters trip point confirmation screen.

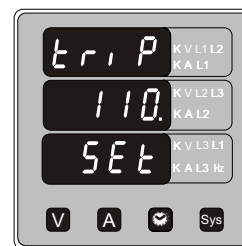

Trip point Confirmation

Pressing "V" re-enters the trip point edit screen. Pressing "A" selects the set trip point and exits the set up menu entering measurement mode.

Note: Fixed hysteresis 5% of trip point.

4. Run Hours

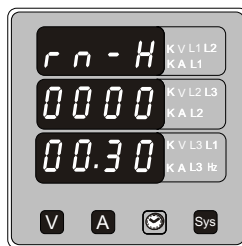

This screen shows the total no. Of hours the Load is connected. Even if the Auxiliary supply is interrupted, count of Run hour will be maintained In internal memory & displayed in the format "Hours.min". For example, if displayed count is 005678.56, then it indicates 5678 hours and 56 minutes.

After 999999.59 count of run hours, display will Start again from zero.

To reset run hour count manually, see section Reset (3.2.6).

5. ON Hours

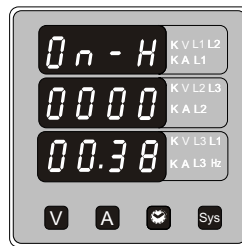

This screen shows the total no. of hours the Auxiliary supply is ON. Even if the Auxiliary supply is interrupted, count of ON hour will be maintained In internal memory & displayed in the format "Hours.min". For example, if displayed count is 014678.23, then it indicates 14678 hours and 23 minutes.

After 999999.59 count of ON hours, display will Start again from zero.

To reset ON hour count manually, see section Reset (3.2.6).

6. Number of interruptions :

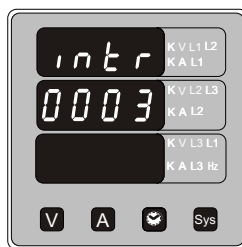

This screen displays the total no. Of times the auxiliary supply was interrupted. Even if the auxiliary Supply is interrupted, the count will be maintained In internal memory.

To reset No. of interruptions count manually, see section Reset (3.2.6).

7. Installation

Mounting of Delta is featured with easy "Clip-in" mounting. Push the meter in panel slot (size 92 x92 mm), it will click fit into panel with the four integral retention clips on two sides of meter. If required Additional support is provided with swivel screws (optional) as shown in figure.

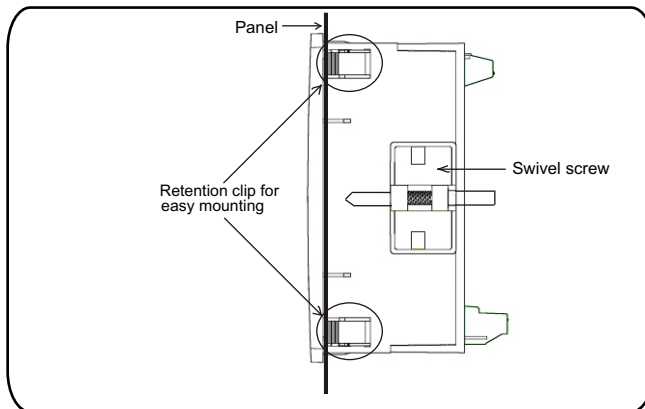

The front of the enclosure conforms to IP50. Additional protection to the panel may be obtained by the use of an optional panel gasket. The terminals at the rear of the product should be protected from liquids.

The Delta 3 Line should be mounted in a reasonably stable ambient temperature and where the operating temperature is within the range 0 to 50 C°. Vibration should be kept to a minimum and the product should not be mounted where it will be subjected to excessive direct sunlight.

Caution

1. In the interest of safety and functionality this product must be installed by a qualified engineer, abiding by any local regulations.
2. Voltages dangerous to human life are present at some of the terminal connections of this unit. Ensure that all supplies are de-energised before attempting any connection or disconnection.
3. These products do not have internal fuses therefore external fuses must be used to ensure safety under fault conditions.

7.1 EMC Installation Requirements

This product has been designed to meet the certification of the EU directives when installed to a good code of practice for EMC in industrial environments, e.g.

Screened output and low signal input leads or have provision for fitting RF suppression components, such as ferrite absorbers, line filters etc., in the event that RF fields cause problems.

Note: It is good practice to install sensitive electronic instruments that are performing critical functions, in EMC enclosures that protect against electrical interference which could cause a disturbance in function.

Avoid routing leads alongside cables and products that are, or could be, a source of interference.

To protect the product against permanent damage, surge transients must be limited to 2kV pk. It is good EMC practice to suppress differential surges to 2kV at the source. The unit has been designed to automatically recover in the event of a high level of transients. In extreme circumstances it may be necessary to temporarily disconnect the auxiliary supply for a period of greater than 5 seconds to restore correct operation.

The Current inputs of these products are designed for connection in to systems via Current Transformers only, where one side is grounded.

ESD precautions must be taken at all times when handling this product.

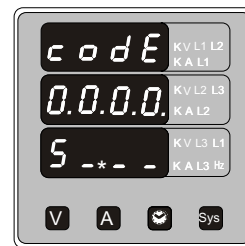

New / Change Password, first digit entered, prompting for second digit. (*Decimal point indicates that this will be flashing).

Pressing the "V" key will scroll the value of second digit from 0 through to 9, the value will wrap from 9 round to 0.

Pressing the "A" key to advance the operation to the Next digit and sets the first digit, in this case to "5"

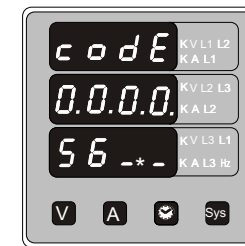

New / Change Password, second digit entered, prompting for third digit. (*decimal point indicates that this will be flashing).

Pressing the "V" key will scroll the value of the third digit from 0 through to 9, the value will wrap from 9 round to 0.

Pressing the "A" key to advance the operation to the next digit and sets the third digit, in this case to "6".

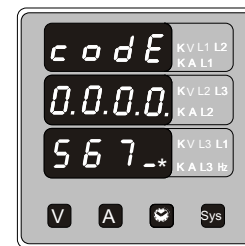

New / Change Password, third digit entered, prompting for fourth digit. (* denotes that decimal point will be flashing).

Pressing the "V" key will scroll the value of the fourth digit from 0 through to 9, the value will wrap from 9 round to 0.

Pressing the "A" key to advance the operation to the "New Password Confirmed" and sets the fourth digit, in this case to "7".

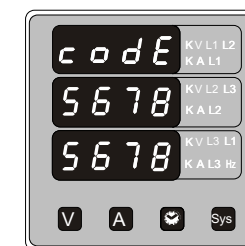

New Password confirmed.

Pressing the "V" key will return to the New/Change Password".

Pressing the "A" key will advances to the Set up screen.(see section 3.2).

3.2 Set Up Screens

3.2.1. System Type

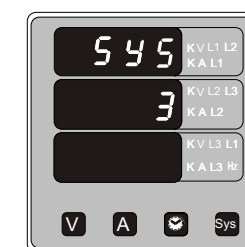

This screen is used to edit and set the system type. System type "3" for 3 phase 3 wire & "4" for 3 phase 4 wire & 1 for Single phase system.

Pressing "A" key accepts present value and advances to the "Potential transformer Primary Value Edit" menu.

Pressing "V" Key will enter the System type edit mode.

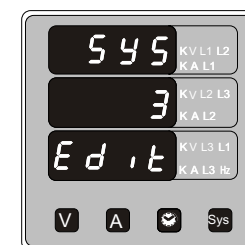

System Type Edit

This screen appears only if "V" key is pressed in previous Menu.

Pressing "V" scrolls through the values available.

Pressing "A" Key advances to the system type Confirmation menu.

System Type Confirmation

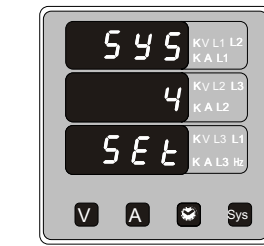

This screen will only appear following the edit of system type.

pressing the "A" key set the displayed value as system Type and will advance to "Potential Transformer Primary Value Edit" menu. (See section 3.2.2)

3.2.2. Potential Transformer Primary Value

The nominal full scale voltage which will be displayed as the Line to Line voltage for all system types. This screen enables the user to display Line to Line and Line to neutral Voltages inclusive of any PT ratios, the values displayed represent the voltage in kilovolts (Note 'K' Annunciator).

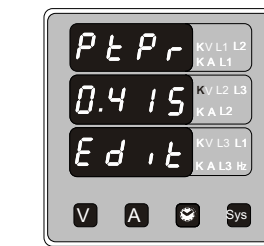

Pressing the "A" key accepts the present value and advances to the "Current Transformer Primary value Edit" menu. (See Section 3.2.3)

Pressing the "V" key will enter the "Potential transformer Primary Value edit mode.

Initially the PT value must be selected pressing the "V" Key will move the decimal point position to the right side Until it reaches ###.# after which it will return to ###

Pressing the "A" key accepts the present multiplier (Decimal Point position) and advances to the "Potential Transformer Primary Digit Edit" Screen.

Note : PT Values must be set as Line to Line Voltage for Primary as well as Secondary for all system types (3P3W/3P4W/1P2W).

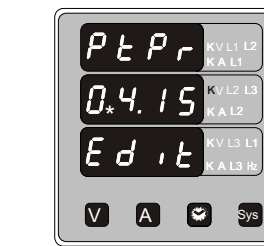

Potential Transformer Primary Digit Edit

Pressing the "V" key will scroll the value of the most significant digit from 0 through to 9 unless the presently displayed Potential Transformer Primary value together with the Current Transformer Primary value previously Set, would result in a maximum power of greater than 1000 MVA per phase in that case the digit range will be Restricted.

Pressing the "A" key accepts the present value at the cursor position and advances the cursor to the next Less significant digit.

Note : the flashing decimal point indicates the cursor position, a steady decimal point will be present to identify the scaling of the number until the cursor position coincides with the steady decimal point position. At this stage the decimal point will flash.

When the least significant digit has been set, pressing the "A" key will advance to the "Potential transformer Primary Value Confirmation" stage.

Screen showing display of 11.00 kV-L i.e. 11000 VoltsLine to Line indicating steady decimal point and cursor flashing at the "hundreds of volts" position as shown below.

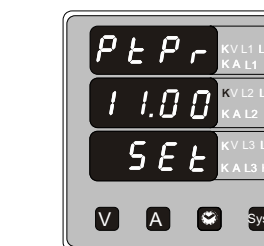

Potential Transformer Primary Value Confirmation

This screen will only appear following an edit of the Potential Transformer Primary Value.

If the set value is to be corrected, pressing the "V" key will return to the "Potential Transformer Primary value Edit" stage with the digits flashing indicating that the Multiplier (decimal point position) should be selected.

Pressing the "A" key sets the displayed value and will advance to the Current Transformer Primary Value. (See section 3.2.3.)

3.2.3. Current Transformer Primary Value

The nominal Full Scale Current that will be displayed as the Line currents. This screen enables the user to display the Line currents inclusive of any transformer ratios, the values displayed represent the Current in Amps.

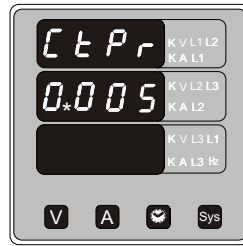

Pressing the "V" key will enter the "Current Transformer Primary Value Edit" mode. Pressing the "A" key will accept the present value And Advances to the "Potential Transformer Secondary Value edit screen (See section 3.2.4)

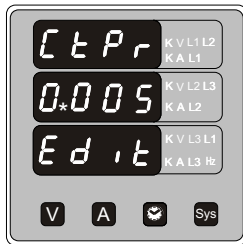

Current Transformer Ratio Edit
Pressing "V" key will advance the Most Significant Digit from 0 through to 9, unless the Current Transformer Primary Value together with the Potential Transformer Primary Value results in a maximum power of greater than 1000 MVA in which case the digit range will be restricted, the value will wrap. Example: If primary value of PT is set as 692.8kV-L (max value) then primary value of Current is restricted to 1736A.

Pressing the "A" key will advance to the next least significant digit. (* Denotes that decimal point will be flashing).

The "Maximum Power" restriction of 1000 MVA refers to 120% of nominal current and 120% of nominal voltage, i.e. 694.4 MVA nominal power per phase.

When the least significant digit had been set, pressing the "A" key will advance to the "Current Transformer Primary Value Confirmation" stage.

The minimum value allowed is 1, the value will be forced to 1 if the display contains zero when "A" key is pressed.

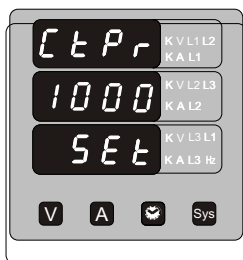

Current Transformer Primary Value Confirmation.

This screen will only appear following an edit of the Current Transformer Primary Value, when "A" key is pressed after Setting value of least significant Digit.

Pressing the "V" key will return back to CT primary edit Menu.

Pressing the "A" key sets the displayed value and then advance to the "Potential Transformer Secondary Value Edit" menu. (See section 3.2.4).

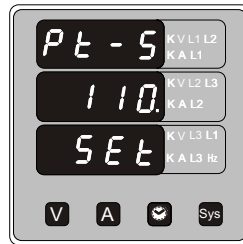

PT Secondary value confirmation

This screen will only appears following an edit of PT secondary value .

If secondary value shown is not correct, pressing the "V" key will return to PT secondary edit stage.

Pressing "A" key sets the displayed value and will advance to CT Secondary Value Edit menu. (See section 3.2.5)

3.2.5. Current Transformer Secondary Value

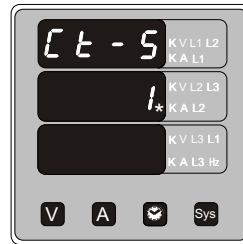

This screen is used to set Current Transformer Secondary Value.

The possible Values for CT Secondary are 1 and 5A.

Pressing "A" key Accepts present Value and advances to To RESET menu.

Pressing "V" will enter the CT Secondary Edit menu.

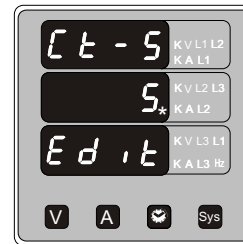

Current Transformer Secondary Value Edit

Pressing "V" will Scroll Value between 1 and 5.

Pressing "A" will enter the CT Secondary Value Confirmation menu.

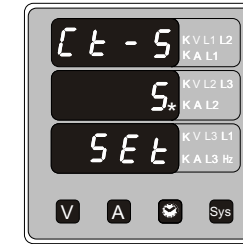

CT Secondary Value Confirmation

Pressing "V" will enter CT Secondary Value Edit Menu.

Pressing "A" will Accept present Value and Advances to RESET menu.

3.2.6. Resets

The following screens allow the users to reset the run hour, ON Hour, No. Of Interruptions, Min and Max. Values of Voltage and Current.

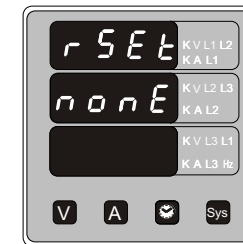

Pressing the "V" key will enter the "Reset edit" menu.

Pressing the "A" key will Reset None and enter to Screen Auto of fixed selection menu.

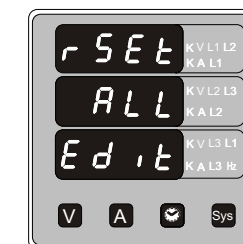

Edit the Reset of Parameters

Pressing "V" will scroll the parameters in sequence as Follow :

1. All : To reset All parameters,
2. Hi : To reset Max values,
3. Lo : To reset min. Values,
4. Hr : To reset Run Hrs, On Hrs,
5. Int : To reset No. Of Interruptions,
6. None : No to reset any of the Parameters,

Select the Correct parameter to Reset and then Press "A". This will enter to Reset Parameter Confirmation Screen.

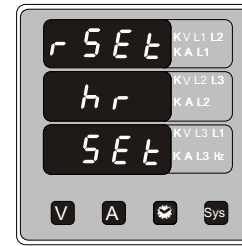

Confirmation of parameter for RESET

Pressing "V" will enter reset menu back and scroll between parameters as above.

Pressing "A" key will Reset the Selected Parameter. In this case hour parameters will get reset. Then it will enter to auto scrolling or fixed screen selection parameter.

3.2.7 Screen Auto scrolling / Fixed Screen selection

This menu allow to select scrolling or fixed Screen

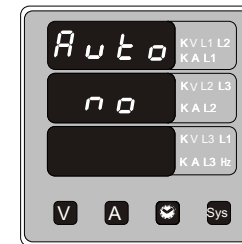

Auto Scrolling Edit

Pressing "A" enters confirmation of Fixed Screen.

Pressing of "V" enters to Edit menu.

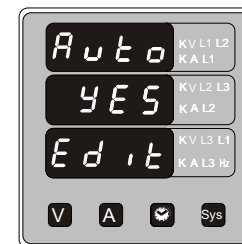

Fixed Screen / Auto Scrolling Edit.

Pressing of "V" Rolls between "Yes" and "No".

Pressing "A" enters Auto scrolling / fixed screen Select confirmation.

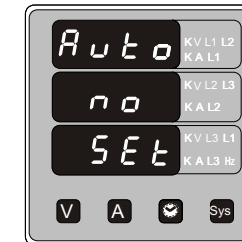

Confirmation of Auto Scrolling / Fixed Screen

Pressing "V" enter back to edit menu.

Pressing "A" confirms the selection and enters Number of poles selection menu.

3.2.8 No. of Poles Selection :

This screen enables to Set No. of poles on a Generator of which RPM is to be measured and to which the instrument is connected to measure its output parameters

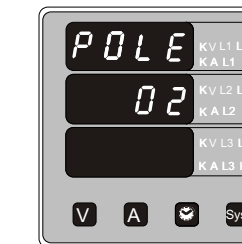

Selection of No. of poles of the Generator

Pressing "V" enters into no. of pole edit menu

Pressing "A" key will set the displayed number as No. of poles. Then it will come out of set Up menu.

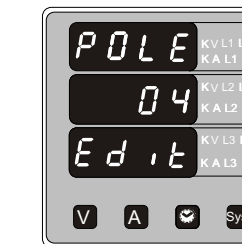

No. of poles edit

Pressing "V" scrolls the number from 02 to 40 in step of 2. After 40 it wraps to the number again 02.

Pressing "A" enters into No. of poles Confirmation Screen.

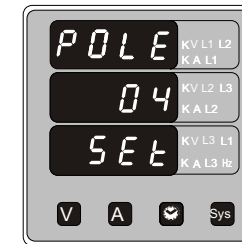

No. of poles Confirmation

Pressing "V" enters back to No. of poles edit Menu.

Pressing "A" sets the number on screen, 4 in this Case, as number of poles of generator. Then it will come out of set Up menu, and enter into normal operation mode.

3.2.9 Relay Limit Parameter selection (Optional)

This screen enables user to select Parameter for limit monitoring via a Relay.

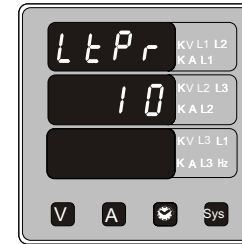

Selection of Parameter

Pressing "A" key selects the displayed parameter for monitoring and enters trip point selection screen.

Pressing "V" key enters Trip parameter edit screen.

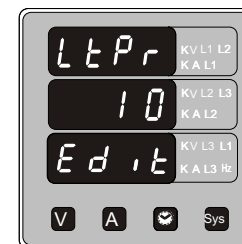

Trip parameter edit screen

Pressing "V" key scrolls the parameters one by one as per table 2.

Selecting 00(None) disables relay function.

Pressing "A" selects the parameter and enters the Trip parameter confirmation screen.

In this case displayed number 10 will select VL1-L2 For relay monitoring as per table 2.

TABLE 2 : Parameters for limit monitoring

Parameter No.	Measured Parameters	3P4W	3P3W	1P2W	Trip point Set range	100% Value
00	None	✓	✓	✓	—	—
01	Voltage L1	✓	X	✓	10 - 120%	Vnom (L-N)
02	Voltage L2	✓	X	X	10 - 120%	Vnom (L-N)
03	Voltage L3	✓	X	X	10 - 120%	Vnom (L-N)
04	Current L1	✓	✓	✓	10 - 120%	Inom
05	Current L2	✓	✓	X	10 - 120%	Inom
06	Current L3	✓	✓	X	10 - 120%	Inom
07	Frequency	✓	✓	✓	10 - 100%	66Hz ⁽¹⁾
10	Voltage VL1-L2	✓	✓	X	10 - 120%	Vn (L-L)
11	Voltage VL2-L3	✓	✓	X	10 - 120%	Vn (L-L)
12	Voltage VL3-L1	✓	✓	X	10 - 120%	Vn (L-L)
13	System Voltage	✓	✓	X	10 - 120%	Vnom ⁽²⁾
14	System Current	✓	✓	X	10 - 120%	Inom

Note : (1) For Frequency 10% corresponds to 45Hz and 100% corresponds to 66Hz.
(2) For 3P 4wire and 1ph the nominal value is V_{LN} and that for 3P3W is V_{LL}.
(3) Nominal Value is to be considered with set CT/ PT Primary values.
(4) For single phase L1 Phase values are to be considered as System values.

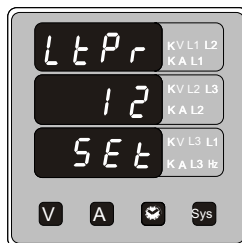

Trip parameter confirmation screen.

This screen will appear only after parameter edit.

Pressing "V" will re-enter the parameter selection menu

Pressing "A" will set the parameter for relay trip and then it will enter the trip point selection menu.

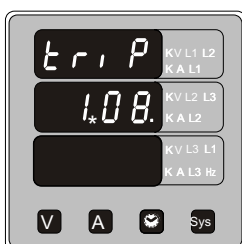

Trip point selection

This screen will not appear if parameter None (00) is Selected in previous menu.

Pressing "V" key will enter trip point edit screen.

Pressing "A" key will set displayed value as trip point and exit set up.